



DetectametTM
manufacturer of detectable safety products

Detectable Knife Guide

How to choose the correct knife for your working environment

**DETECTABLE
KNIVES
INSIDE**



Detectable Knife Guide 2020



detectamet.co.uk



detectamet.com



detectamet.ca



detectamet-products.com.au

Accreditations



At Detectamet we take our business very seriously, which is why we are ISO accredited in 9001: Quality Management, 14001: Environmental Management and 45001: Occupational Health and Safety

Awards - Over the years, we've collected awards for our innovative products



**Chamber
Bridlington
& Central Coast
Business Awards**

Why you need detectable products:

Food, drink and pharmaceutical industries need to prevent/reduce the risk of foreign body contamination. Physical contaminants can damage equipment and cause injury. If they reach the consumer you will be faced with an expensive recall, which could harm your reputation. The safest way to eliminate and protect against this risk is to use metal detectable and X-Ray visible products in all areas of your product preparation areas.

What do you get from Detectamet:

Detectamet's product range offers you the best detectability, made from a patented, unique polymer that contains the highest level of detectable additive, without compromising on durability, and manufactured from EU & FDA (Food and Drug Administration) food contact approved materials.

- Patented, unique polymer - contains highest levels of detectable additive in the market
- All products comply with EU and FDA food contact regulations
- Durable products - minimise risk of breaking
- Largest range of detectable products on the market
- Branding/serialisation available with in-house laser engraver/pad printer

Contents

Understanding our Safety Knives and their capabilities	3
Detectable Disposable Safety Knife Range	4-8
Detectable Normal Duty Safety Knife Range	9-11
Detectable Heavy Duty Safety Knife Range	11-14
Sequential Numbering Information	14
Security Cage	15
Locking Knives	16-17
Professional Knives	18-23
Knife Safety Information and Contact Details	24

In Partnership
with

BRCS

2

Detectamet

Detectable Safety Knife Features

Ensure you choose the correct knife for your required purpose by consulting the Safety Knife Features outlined below and listed on each product description.



Replacement Blades Available

We offer replacement blades for many of our safety knives.



Cardboard

Suitable for cutting through cardboard packaging. For consistent cutting of thicker cardboard, we recommend our Heavy Duty Knife Range.



Plastic Wrapping

Suitable for cutting through plastic wrapping.



Sacks/Plastic Bags

Suitable for cutting through plastic sacks and bags.



Plastic Netting

Suitable for cutting through plastic netting.



Plastic Adhesive Tape

Suitable for cutting through plastic adhesive tape.



Bubble Wrap

Suitable for cutting through bubble wrap.



Plastic Strapping

Suitable for cutting through plastic strapping, usually found wrapped around cardboard boxes.



Retractable Blade

Some of our detectable knives are retractable for added safety.

Disposable Knife Range

A lightweight, shorter-lasting knife that is disposable. Suitable for lighter materials such as thinner cardboard and plastic wrapping.

Normal Duty Knife Range

A longer-lasting knife, capable of cutting a variety of products, from lighter materials to thicker plastics and card.

Heavy Duty Knife Range

Our longest lasting range of knives, resilient to consistent cutting of thicker packaging, including heavy duty cardboard.

Disposable Metal Detectable Safety Knives with Auto Retracting Blade

FR: Couteau de sécurité à lame jetable
 ES: Navaja de seguridad con hoja desechable
 DE: Sicherheitsmesser mit Einwegklinge

These detectable disposable safety knives are light and compact in shape and ideal for cutting packaging.

SUITABLE FOR LASER ENGRAVING

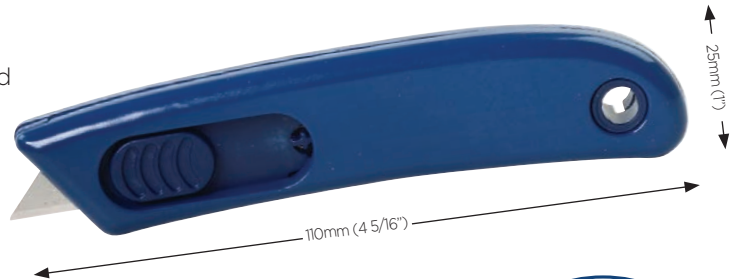

Features & Options

5 PACK



Colour: ■

- Retractable Blade
- Cardboard
- Plastic Wrapping
- Plastic Adhesive Tape

STAINLESS STEEL BLADE

AUTOMATIC BLADE RETRACTION



PRODUCT CODE: 615-K104-T184-P01

More product codes available – please contact us for a full price list

Disposable Metal Detectable Safety Knives with Hook Blade

FR: Couteau de sécurité multi-usage
 ES: Navaja de seguridad multifunción
 DE: Mehrzweck-Sicherheitsmesser



SUITABLE FOR AMBIDEXTROUS USE

LANYARD POINT

ONE-PIECE

These disposable, lightweight detectable safety knives have an enclosed blade, optional hook and tape cutter and are suitable for light use.



Features & Options

5 PACK



Colours: ■ ■ ■ ■

- Cardboard
- Plastic Wrapping
- Plastic Netting
- Plastic Adhesive Tape
- Bubble Wrap
- Plastic Strapping

ENCLOSED STAINLESS STEEL BLADE

SUITABLE FOR LASER ENGRAVING



HOOK (T194)

CUTTER (T193)

STANDARD (T192)

PRODUCT CODE: 615-K108-T194-P01

Disposable Metal Detectable Safety Knives with Enclosed Blades and Tape Cutter



FR: Cutter pour emballage robuste
 ES: Cortador de envoltorios de alta resistencia
 DE: Kraftschneidwerkzeug

These disposable, heavy duty detectable safety knives have enclosed blades and a tape cutter on the end and are suitable for all packaging use.

OPPOSING SLOPES ON KNIFE HEAD REDUCE FRICTION FOR A MORE EFFICIENT CUT

SUITABLE FOR LASER ENGRAVING



Features & Options

5 PACK



Colours:

ONE-PIECE

ENCLOSED STAINLESS STEEL BLADES

SUITABLE FOR AMBIDEXTROUS USE

LANYARD POINT

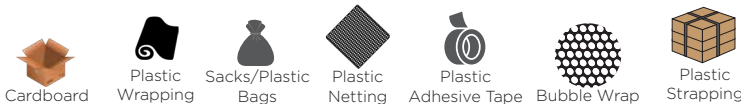

PRODUCT CODE: 615-K107-T031-P0

Sequential numbering available for all products

Disposable Metal Detectable Bag Cutters with Enclosed Blade



FR: Cutter à sac
 ES: Cortador de bolsas en forma de cisne
 DE: Tütenschneider in Schwanform

These disposable, detectable bag cutters have an additional tape cutter and the pointed nose punctures material, making them great for general warehouse use.

SUITABLE FOR AMBIDEXTROUS USE

OPPOSING SLOPES ON KNIFE HEAD REDUCE FRICTION FOR A MORE EFFICIENT CUT



ONE-PIECE

LANYARD POINT

SUITABLE FOR LASER ENGRAVING

ENCLOSED STAINLESS STEEL BLADE

Features & Options

5 PACK



Colour:



PRODUCT CODE: 615-K116-T035-P01

Disposable Metal Detectable Safety Knives with Dual Enclosed Blades

FR: Couteau de sécurité compact à double lame
ES: Navaja de seguridad compacta de hoja doble
DE: Kompaktes Sicherheitsmesser mit Doppelklinge

These are economical, disposable detectable safety knives. With two cutting edges they last twice as long, reducing your plastic waste, and are suitable for many types of packaging.

Features & Options

5 PACK



Colour: ■

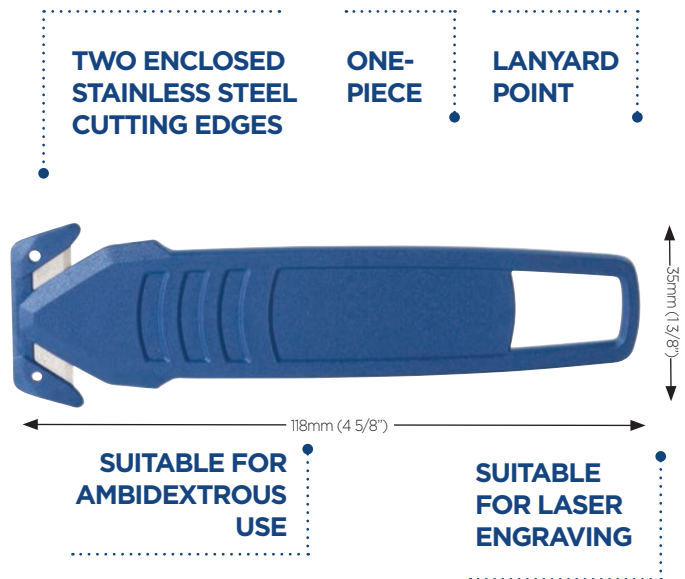
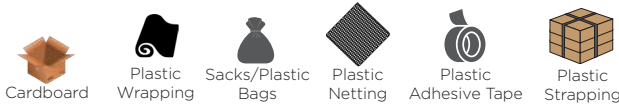

PRODUCT CODE: 615-K122-T184-P01

More product codes available – please contact us for a full price list

Disposable Metal Detectable Safety Knives with Enclosed Blade and Retractable Hook Blade



FR: Couteau de sécurité à lame crochet rétractable
ES: Navaja de seguridad con hoja en gancho retráctil
DE: Sicherheitsmesser mit einziehbarer Hakenklinge

These detectable, disposable safety knives come with an auto retracting hook blade and are suitable for plastic packaging and light cardboard use.

Features & Options

5 PACK



Colour: ■

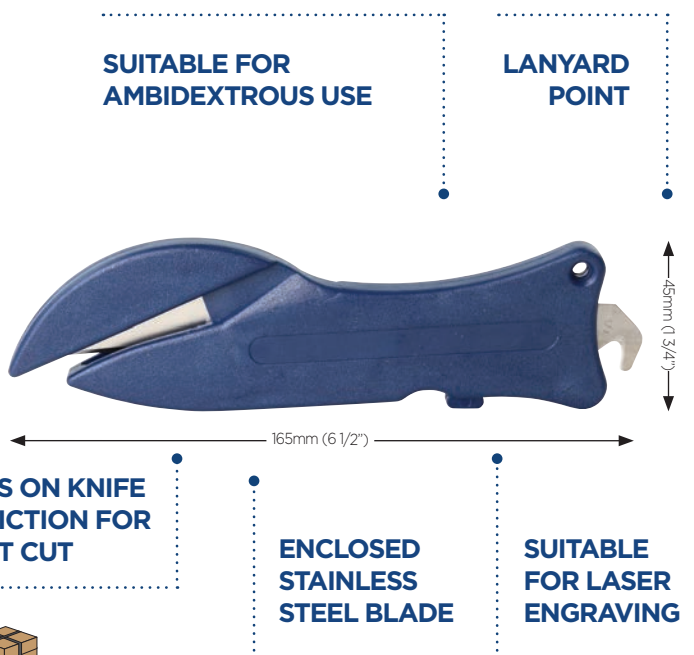

PRODUCT CODE: 615-K117-T196-P01

Disposable Safety Knives with Enclosed Blade and Tape Cutter

FR: Couteau de sécurité SK127 avec protégé-lame et coupe-ruban

ES: SK127 navaja de seguridad con cortador de cinta y cuchilla cerrada

DE: SK127 sicherheitsmesser mit abgedeckter klinge und bandabschneider

These disposable detectable safety knives have an enclosed blade plus tape cutter and are suitable for all plastic packaging.



ENCLOSED
STAINLESS
STEEL BLADE

SUITABLE
FOR LASER
ENGRAVING

ERGONOMIC
HANDLE GRIP

TAPE
CUTTER

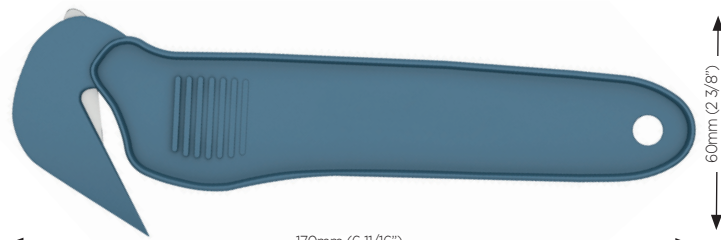

LANYARD
POINT

SUITABLE FOR
AMBIDEXTROUS
USE

POINTED NOSE
FOR OPENING
INGREDIENT BAGS

Features & Options

5
PACK



Colour: ■



PRODUCT CODE: 615-K127-T538-P01

Sequential numbering available for all products

Disposable Metal Detectable Plastic Sheet Cutters with Enclosed Blade

FR: Mini cutter coupe-film

ES: Minicortador de láminas de plástico

DE: Mini-Folienschneider

These disposable, detectable mini plastic sheet cutters have an enclosed blade and a point to puncture packaging.

ONE-PIECE

SUITABLE FOR
AMBIDEXTROUS
USE



Features & Options

5
PACK



Colour: ■



SUITABLE FOR
LASER ENGRAVING

ENCLOSED STAINLESS
STEEL BLADE

PRODUCT CODE: 615-K121-T184-P01

Disposable Metal Detectable Safety Knives with Enclosed Blade

FR: Cutter pour emballage

ES: Cortador de envoltorios

DE: Schneidwerkzeug



These lightweight disposable, detectable safety knives have an enclosed blade and a pointed nose to puncture packaging.

Features & Options

- Metal detectable
- Enclosed stainless steel blade
- One-piece
- Suitable for ambidextrous use
- Suitable for laser engraving

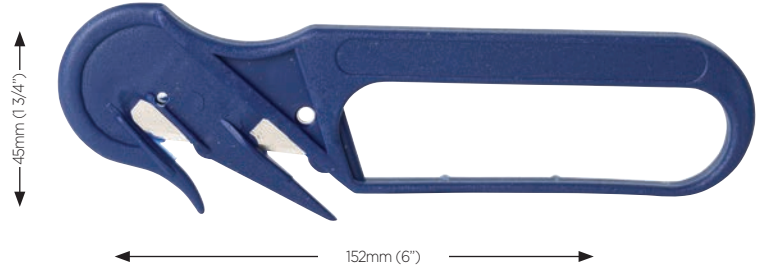

Colours:



PRODUCT CODE: 615-K106-T030-PO

More product codes available – please contact us for a full price list

Disposable Metal Detectable Ring Safety Knives

FR: Anneau pour couteau de sécurité

ES: Anillo con navaja de seguridad

DE: Sicherheitsmesserring



These disposable, detectable ring safety knives can be worn at all times, allowing the wearer to keep both hands free and are suitable for cutting plastic wrapping.



Colour:

Features & Options

- Metal detectable
- Enclosed stainless steel blade
- One-piece
- Suitable for ambidextrous use
- Suitable for laser engraving



PRODUCT CODE: 615-K123-T184-P01

Detectable Knife Guide Normal Duty Knife Range

Normal Duty Metal Detectable Safety Knife

FR: Couteau de sécurité à lame rétractable
 ES: Navaja de seguridad con hoja retráctil
 DE: Sicherheitsmesser mit einziehbarer Klinge

This detectable safety knife has blade lock control for when a cut is being made, it **automatically retracts with sudden movements** and is suitable for all packaging use.



AUTOMATIC BLADE RETRACTION



SUITABLE FOR AMBIDEXTROUS USE

SECURITY KEY FOR CONTROLLED BLADE CHANGE



Features & Options 1 PACK



Colour:

- Retractable Blade
- Replacement Blades
- Cardboard
- Plastic Wrapping
- Sacks/Plastic Bags
- Plastic Netting
- Plastic Adhesive Tape
- Bubble Wrap
- Plastic Strapping

STAINLESS STEEL BLADE

SUITABLE FOR LASER ENGRAVING

REPLACEMENT BLADES AVAILABLE WITH TWO CUTTING EDGES

PRODUCT CODE: 615R-K119-T037-A117

Sequential numbering available for all products

Normal Duty Metal Detectable Safety Knife with Enclosed Blade and Tape Cutter

FR: Couteau de sécurité avec lame fermée et coupe-bande
 ES: Cuchillo de seguridad con hoja oculta y cortador de cinta
 DE: Sicherheitsmesser mit abgedeckter Klinge und Bandabschneider

This detectable safety knife has an enclosed blade plus tape cutter, replaceable blades with four cutting edges and is suitable for all packaging.



TAPE CUTTER

LANYARD POINT

SUITABLE FOR AMBIDEXTROUS USE



Features & Options 1 PACK



Colour:

- Replacement Blades
- Cardboard
- Plastic Wrapping
- Sacks/Plastic Bags
- Plastic Adhesive Tape
- Plastic Strapping

REPLACEMENT BLADES AVAILABLE WITH FOUR CUTTING EDGES

ENCLOSED STAINLESS STEEL BLADE

SUITABLE FOR LASER ENGRAVING

PRODUCT CODE: 615-K126-T184-P01

In Partnership with
BROGS



Detectamet

Normal Duty Metal Detectable Safety Knives

FR: Couteau de sécurité économique à lame rétractable

ES: Navaja de seguridad económica con hoja retráctil

DE: Preisgünstiges Sicherheitsmesser mit einziehbarer Klinge

These detectable safety knives are ideal for general packaging use, including 2-ply cardboard.

Features & Options

5
PACK



STAINLESS STEEL BODY WITH BLUE DETECTABLE PLASTIC PARTS

STAINLESS STEEL DOUBLE EDGED BLADE

Colour:



SEMI-AUTOMATIC BLADE RETRACTION

SUITABLE FOR LASER ENGRAVING

100mm (3 15/16")

SUITABLE FOR AMBIDEXTROUS USE

REPLACEMENT BLADES AVAILABLE WITH FOUR CUTTING EDGES

255mm (10")

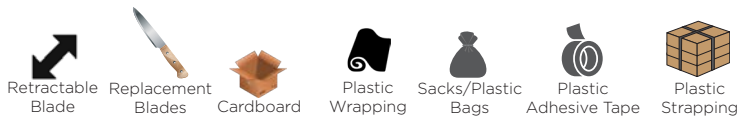

PRODUCT CODE: 615-K124-T184-P01

More product codes available – please contact us for a full price list

Normal Duty Metal Detectable Safety Knives with Dual Enclosed Blades and Tape Cutter

FR: Couteau double lame

ES: Navaja de hoja doble en forma de cangrejo

DE: Krebsmesser mit Doppelklinge

These compact detectable safety knives have a blunt tape cutter and twin blades for push/pull cutting techniques.



5
PACK

Features & Options

- Metal detectable
- Enclosed stainless steel blades
- Blunt tape cutter
- One-piece
- Lanyard point
- Suitable for ambidextrous use
- Suitable for laser engraving

Colour:

60mm (2 3/8")



120mm (4 3/4")

SUITABLE FOR LASER ENGRAVING

SUITABLE FOR AMBIDEXTROUS USE



PRODUCT CODE: 615-K115-T132-P01

Normal Duty Metal Detectable & X-Ray Visible Stainless Steel Safety Knife with Auto Retracting Blade

FR: Couteau de sécurité rétractable en acier inoxydable
ES: Navaja de seguridad retráctil de acero inoxidable
DE: Sicherheitsmesser mit einziehbarer Klinge aus Edelstahl
 This fully detectable, retractable safety knife is manufactured from stainless steel.

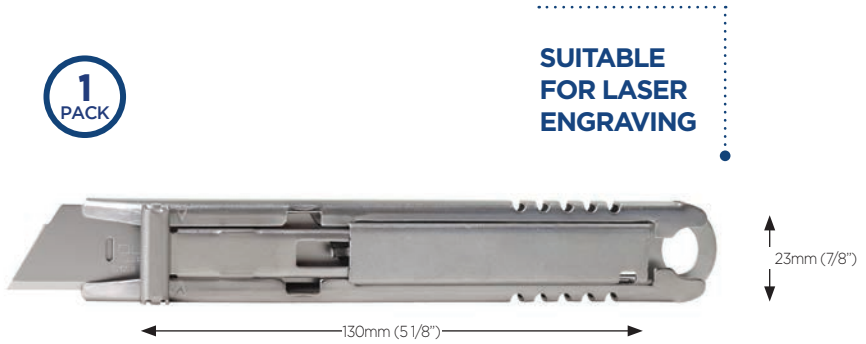

Features & Options

- Metal detectable
- X-Ray visible
- Automatic blade retraction
- NSF certifiable
- Replacement blades available
- Suitable for ambidextrous use
- Suitable for laser engraving

Colour:



PRODUCT CODE: 615-K125-T513-P45

Sequential numbering available for all products

Heavy Duty Metal Detectable Aluminium Safety Knife

FR: Couteau de sécurité robuste
ES: Navaja de seguridad de alta resistencia
DE: Extrastarkes Sicherheitsmesser

This detectable safety knife is heavy duty and ideal for cutting packaging, including thicker cardboard.

STAINLESS STEEL DOUBLE EDGED BLADE
SUITABLE FOR AMBIDEXTRIOUS USE
SUITABLE FOR LASER ENGRAVING

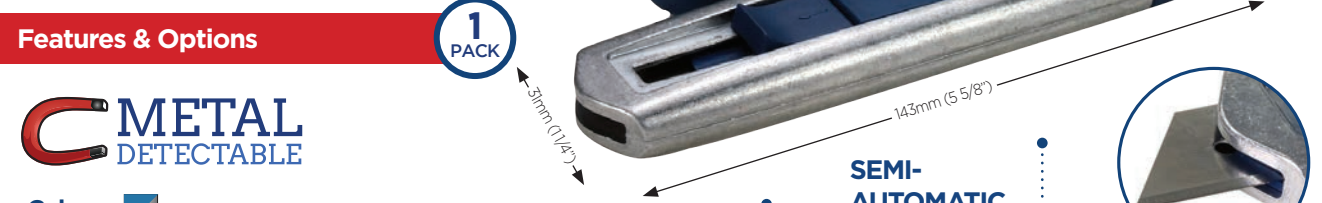

Features & Options



Colour:

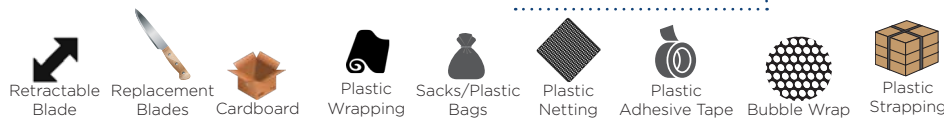

ALUMINIUM BODY WITH BLUE DETECTABLE PLASTIC PARTS
SEMI-AUTOMATIC BLADE RETRACTION
REVERSIBLE REPLACEMENT BLADES AVAILABLE

PRODUCT CODE: 615-K102-T038-P30

In Partnership with
BROGS

11

detectamet

Heavy Duty Metal Detectable Safety Knife



FR: Couteau de sécurité robuste

ES: Cuchillo de seguridad de alta resistencia

DE: Extrastarkes Sicherheitsmesser

This heavy duty detectable safety knife has blade lock control for when a cut is being made and **automatically retracts with sudden movements**. Its aluminium blade carrier makes blade changing easier, particularly important for high cardboard use resulting in frequent blade changes.

SUITABLE FOR
AMBIDEXTROUS
USE

SECURITY KEY
FOR CONTROLLED
BLADE CHANGE



Features & Options

1
PACK



Colour: ■

STAINLESS
STEEL BLADE

SUITABLE
FOR LASER
ENGRAVING

REPLACEMENT BLADES
AVAILABLE WITH TWO
CUTTING EDGES



PRODUCT CODE: 615R-K120-T037-A118

More product codes available – please contact us for a full price list

In Partnership with
BROGS

12

Heavy Duty Metal Detectable Safety Knife with Enclosed Blade



FR: Couteau de sécurité robuste

ES: Navaja de seguridad de alta resistencia

DE: Extrastarkes Sicherheitsmesser

This heavy duty detectable safety knife has an enclosed blade, is available with/without a retractable hook, has replaceable reversible blades and is suitable for most packaging.

REPLACEMENT
REVERSIBLE
BLADES
AVAILABLE

SUITABLE FOR
AMBIDEXTROUS
USE

RETRACTABLE
HOOK OPTION



STANDARD
(T192)



Features & Options

1
PACK



Colour: ■

OPPOSING SLOPES AT
MOUTH EXIT REDUCE
FRICTION FOR A
MORE EFFICIENT CUT

ENCLOSED
STAINLESS
STEEL BLADE

SUITABLE
FOR LASER
ENGRAVING



PRODUCT CODE: 615-K118-T197-P01

Detectamet

Heavy Duty Metal Detectable Safety Knives with Enclosed Blade



FR: Couteau de sécurité à lame crochet
 ES: Navaja de seguridad con hoja en gancho
 DE: Sicherheitsmesser mit Hakenklinge

These lightweight detectable safety knives have an enclosed blade, hook and tape cutter options, replaceable reversible blades and are suitable for most packaging.

Features & Options 5 PACK



Colour:



REPLACEMENT REVERSIBLE BLADES AVAILABLE

SUITABLE FOR AMBIDEXTROUS USE

HOOK AND TAPE CUTTER OPTIONS

LANYARD POINT

ENCLOSED STAINLESS STEEL BLADE

SUITABLE FOR LASER ENGRAVING



PRODUCT CODE: 615-K109-T195-P01

Sequential numbering available for all products

Heavy Duty Metal Detectable Box Cutter



FR: Cutter à lame Vari-guard rétractable
 ES: Cortador de cajas con vari-guard retráctil
 DE: Teppichmesser mit einziehbarem Vari-Schutz

1
PACK

This heavy duty detectable box cutter has spring loaded retractable guards and reversible replacement blades. It is perfect for cutting boxes without damaging contents and most plastic packaging.

Features & Options

- Metal detectable
- Enclosed stainless steel blade
- Security key for safe blade change
- Lanyard point
- Replacement blades available for cutting and hook blade
- Suitable for ambidextrous use
- Suitable for laser engraving



SUITABLE FOR AMBIDEXTROUS USE

Colour:

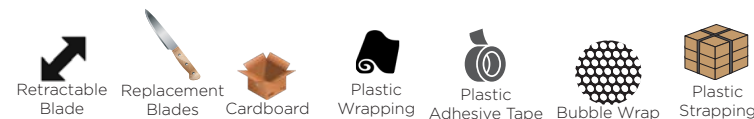

PRODUCT CODE: 615-K112-T034-P27

In Partnership with
BROGS

13

Detectamet

Heavy Duty Metal Detectable Box Cutter with Hook Blade



FR: Cutter

ES: Cortador de cajas

DE: Teppichmesser



This heavy duty detectable box cutter has a hook blade, an enclosed blade with spring loaded retractable guards and reversible replacement blades. It is perfect for cutting boxes without damaging contents and most plastic packaging.

Features & Options

- Metal detectable
- Enclosed stainless steel blade
- Hook blade to puncture into material
- Security key for safe blade change
- Replacement blades available
- Lanyard point
- Suitable for ambidextrous use
- Suitable for laser engraving

45mm (1 3/4")



150mm (5 7/8")

Colour: ■

**SUITABLE FOR
AMBIDEXTROUS
USE**



PRODUCT CODE: 615-K111-T033-P01

Ensure complete traceability with sequential numbering on your products

Using detectable equipment is an essential step towards preventing foreign body contamination. However, mistakes do happen, and equipment can go missing during a shift. Sequential numbering gives you complete traceability and is particularly important if production presents higher risks, making it even more important to eliminate any type of contamination.

Detectamet offer a laser engraving service which adds sequential numbers onto your knives (and other products).

This allows you to record knives issued to staff at the start of a shift, check against that record at the end of the shift and if a missing tool is discovered, investigate its whereabouts immediately.

The safest way to eliminate and protect against this risk is to use metal detectable and X-Ray visible products in all areas of your product preparation areas.

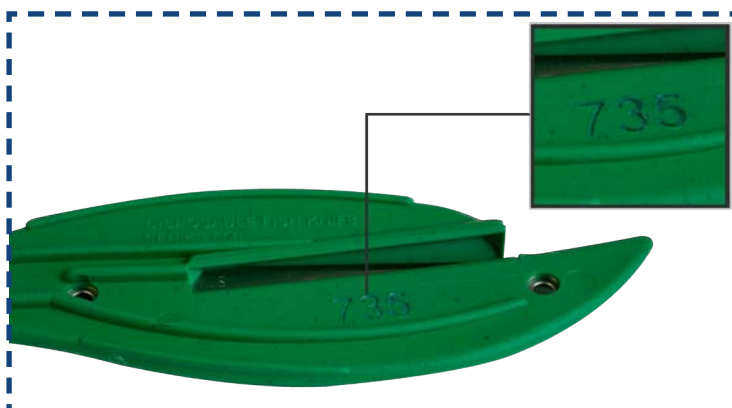

**SEQUENTIAL PRODUCT
NUMBERING AVAILABLE
TO ENHANCE
TRACEABILITY**

Security Cage

FR: Cages de sécurité
ES: Jaulas de seguridad
DE: Kasten mit Sicherheitsgitter



Keep tools safe and secure with this lockable security cage, contributing to internal traceability systems.



Features & Options

- Metal detectable
- X-Ray visible
- Reduces risk of cross contamination
- Completely customisable
- Supplied with stainless steel fittings/purpose built holders for hanging/securing tools
- Lockable
- Size shown: 350 x 75 x 500mm (13 3/4 x 2 15/16 x 19 11/16")
- Bespoke sizes available
- Site visits available



LOCKABLE

BESPOKE SIZES AVAILABLE



Colours:

PRODUCT CODE: 621-P45

Call us now to talk through your requirements:

Detectamet UK: +44 1759 304200 / Detectamet USA: +1-804-303-1983

Detectamet Canada: +1-613-736-6560 / Detectamet Australia: +61 2 9058 8555

In Partnership with
BROGS

15

Detectamet

Metal detectable and X-Ray visible **locking knives** are ideal for general purpose use

In Partnership with
BRGS

16

Detectamet



↑ **DETECTABLE HANDLES** ↑

Metal Detectable & X-Ray Visible Locking Knife with Lambfoot Blade

FR: Couteau verrouillable avec lame lambfoot (pied d'agneau)

ES: Navaja con hoja de espalda recta

DE: Feststellbares messer mit gerader klinge (lambfoot)



This heavy duty locking knife comes with a blue detectable handle and has a stainless steel lambsfoot blade, making it ideal for general purpose use.



Features & Options

- Metal detectable
- X-Ray visible
- High carbon stainless steel lockable blade
- Blade has flat cutting edge and a back that curves to the point

DETECTABLE

- Also available with a shackle (additional cost applicable)
- Blade length: 55mm
- Suitable for pad printing/laser engraving
- This is not a safety knife

Colour: ■



PRODUCT CODE: 605-T042-P01

Sequential numbering available for all products

Metal Detectable & X-Ray Visible Locking Knife with Sheepfoot Blade

FR: Couteau verrouillable avec lame sheepfoot (pied de mouton)

ES: Navaja con hoja de punta caída

DE: Feststellbares messer mit gerader klinge (sheepfoot)



This heavy duty locking knife comes with a blue detectable handle and has a stainless steel sheepfoot blade, making it ideal for general purpose use.



Features & Options

- Metal detectable
- X-Ray visible
- High carbon stainless steel lockable blade
- Blade has straight edge and straight back that curves towards the edge at the end, giving excellent control
- Also available with a shackle (additional cost applicable)
- Blade length: 55mm
- Suitable for pad printing/laser engraving
- This is not a safety knife

DETECTABLE

Colour: ■



PRODUCT CODE: 605-T043-P01

Metal Detectable & X-Ray Visible Locking Knife with Clip Point Blade

FR: Couteau verrouillable avec lame clip point

ES: Navaja con hoja punta de clip

DE: Feststellbares messer mit clip-point-klinge



This heavy duty locking knife comes with a blue detectable handle and has a stainless steel clip point blade, making it ideal for general purpose use.



Features & Options

- Metal detectable
- X-Ray visible
- High carbon stainless steel lockable blade
- Pointed blade is useful for piercing materials

DETECTABLE

- Also available with a shackle (additional cost applicable)
- Blade length: 70mm
- Suitable for pad printing/laser engraving
- This is not a safety knife

Colour: ■



PRODUCT CODE: 605-T044-P01

Metal Detectable & X-Ray Visible Locking Knife with Pruning Blade

FR: Couteau verrouillable avec lame a élaguer

ES: Navaja de hoja serrada

DE: Feststellbares gärtnermesser



This heavy duty locking knife comes with a blue detectable handle and has a stainless steel pruning blade, making it ideal for gardening, farming and general purpose use.



Features & Options

- Metal detectable
- X-Ray visible
- High carbon stainless steel locking blade
- Curved blade, sharpened on concave edge

DETECTABLE

- Also available with a shackle (additional cost applicable)
- Blade length: 60mm
- Suitable for pad printing/laser engraving
- This is not a safety knife

Colour:



PRODUCT CODE: 605-T045-P01

Metal Detectable & X-Ray Visible Stainless Steel Locking Knife with All Purpose Blade

FR: Couteau verrouillable en acier inoxydable avec lame tous usages

ES: Navaja de acero inoxidable multiusos

DE: Feststellbares Edelmessmesser Mit Allzweckklinge



This locking knife has a carbon stainless steel general purpose blade and satin finish stainless steel handle, making it ideal for farming and general purpose use.



Features & Options

- Metal detectable
- X-Ray visible
- High carbon stainless steel locking blade
- All purpose blade suitable for multiple applications

- Also available with a shackle (additional cost applicable)
- Blade length: 70mm
- Suitable for pad printing/laser engraving
- This is not a safety knife

Colour:



PRODUCT CODE: 606-Q04-T220

More product codes available – please contact us for a full price list

Metal Detectable & X-Ray Visible Stainless Steel Locking Knife with Pruning Blade

FR: Couteau verrouillable en acier inoxydable avec lame a élaguer

ES: Navaja de acero inoxidable con hoja serrada

DE: Feststellbares gärtnermesser aus edelstahl



This locking knife has a carbon stainless steel pruning blade and satin finish stainless steel handle, making it ideal for farming and general purpose use.



Features & Options

- Metal detectable
- X-Ray visible
- High carbon stainless steel locking blade
- Curved blade, sharpened on concave edge

- Also available with a shackle (additional cost applicable)
- Blade length: 70mm
- Suitable for pad printing/laser engraving
- This is not a safety knife

Colour:



PRODUCT CODE: 606-Q05-T223

Metal Detectable & X-Ray Visible Stainless Steel Locking Knife with Drop Point Blade

FR: Couteau verrouillable en acier inoxydable avec lame drop point

ES: Navaja de acero inoxidable con hoja en punta

DE: Feststellbares edelmessmesser mit drop-point-klinge



This locking knife has a polished carbon stainless steel drop point blade and satin finish stainless steel handle, making it ideal for general purpose use.



Features & Options

- Metal detectable
- X-Ray visible
- High carbon stainless steel locking blade
- Blade spine slopes from handle to tip

- Also available with a shackle (additional cost applicable)
- Blade length: 60mm
- Suitable for pad printing/laser engraving
- This is not a safety knife

Colour:



PRODUCT CODE: 606-Q06-T226

PROFESSIONAL KNIVES

Our detectable professional knives are made from fully hardened and tempered stainless steel to ensure maximum edge retention.

The handles are manufactured from EU & FDA food contact approved detectable polymer.

To achieve maximum hygiene levels, handles are insert moulded to the blades, preventing build-up of contaminants and allowing it to withstand rigorous sterilising and dishwasher use.



In Partnership with
BRCGS

18

Handles

Depending on knife function and frequency of use, handles come in two different shapes:

Regular – designed for holding the knife safely and comfortably for long periods



Ergo – designed for all day use by reducing stress to the hand and wrist and providing thumb support



Edges and Blades

We offer three different types of blade, dependent on function:



Plain – ensures a fine, robust, long lasting edge, predominantly used in the meat processing industry



Serrated/wavy – the teeth along the blade edge allows a tough cut, whilst protecting the softer inner of a product. This is the perfect edge for cutting bread and pastry



Scalloped – with scallops running on each side of the blade, air can enter between the blade and cut products, allowing the cut slice to easily fall away making it perfect for slicing meat

Colour Coding System

It is crucial to minimise the spread of contamination when dealing with certain allergens that could present a serious threat to health or life. To minimise this risk our knife handles are available in nine detectable colours.



etectamet

Metal Detectable & X-Ray Visible Vegetable Knives

FR: Couteau à légumes
 ES: Cuchillo para verduras
 DE: Gemüseputzmesser



These vegetable knives come in three different blade lengths, have various blade and tip options and are available in nine different colours.

Features & Options

10
PACK



Colours:

HARDENED AND TEMPERED STAINLESS STEEL

DETECTABLE REGULAR OR ERGO HANDLE

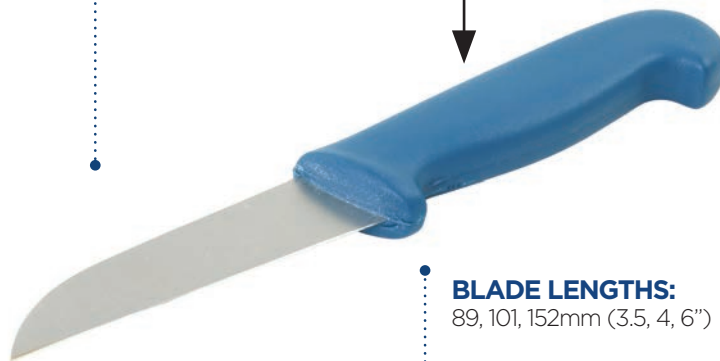

BLADE LENGTHS:
89, 101, 152mm (3.5, 4, 6")

STRAIGHT, STRAIGHT TIP & BLUNT END BLADES AVAILABLE

SUITABLE FOR PAD PRINTING/LASER ENGRAVING

HANDLE MANUFACTURED FROM EU & FDA FOOD CONTACT APPROVED DETECTABLE POLYMER

PRODUCT CODE: 600-T20 (straight blade)

Sequential numbering available for all products

Metal Detectable & X-Ray Visible Chef's Knives

FR: Couteaux de chef
 ES: Cuchillos de chef
 DE: Kochmesser



Chef's knives are one of the most commonly used knives in the commercial kitchen and we offer a wide range of blade sizes, each available in nine different colours.

Features & Options

10
PACK



Colours:

HARDENED AND TEMPERED STAINLESS STEEL

DETECTABLE REGULAR HANDLE



BLADE LENGTHS:
159, 179, 216, 254, 305mm
(6 1/4, 7, 8.5, 10, 12")

STRAIGHT BLADE

SUITABLE FOR PAD PRINTING/LASER ENGRAVING

HANDLE MANUFACTURED FROM EU & FDA FOOD CONTACT APPROVED DETECTABLE POLYMER

PRODUCT CODE: 600-T047

Metal Detectable & X-Ray Visible Boning Knives

FR: Couteau à désosser

ES: Cuchillo para deshuesar

DE: Ausbeinmesser



These detectable boning knives come in two blade lengths and types, all available in nine different colours.

Features & Options

10
PACK



Colours:

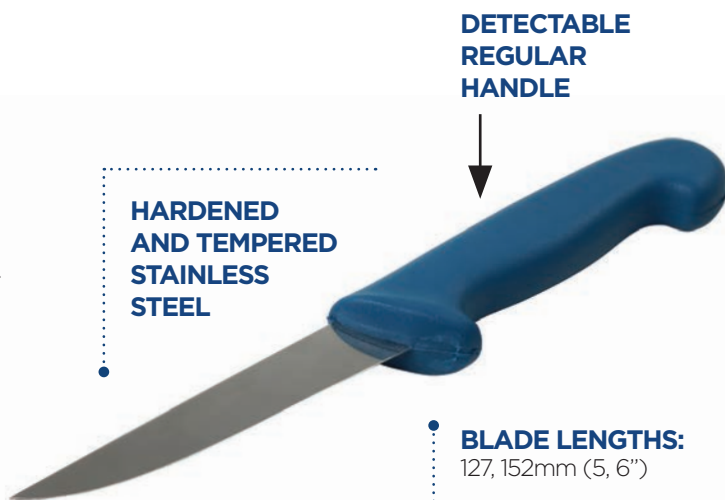

HARDENED AND TEMPERED STAINLESS STEEL

DETECTABLE REGULAR HANDLE

STRAIGHT AND CURVED BLADES AVAILABLE

BLADE LENGTHS:
127, 152mm (5, 6")

SUITABLE FOR PAD PRINTING/LASER ENGRAVING

HANDLE MANUFACTURED FROM EU & FDA FOOD CONTACT APPROVED DETECTABLE POLYMER

PRODUCT CODE: 600-T052 (straight blade)

More product codes available – please contact us for a full price list

Metal Detectable & X-Ray Visible Turning Knives

FR: Couteaux à éplucher

ES: Cuchillos peladores

DE: Tourniermesser



These detectable turning/peeling knives have a 57mm (2.25") curved blade and are available in nine different colours.

Features & Options

10
PACK



Colours:

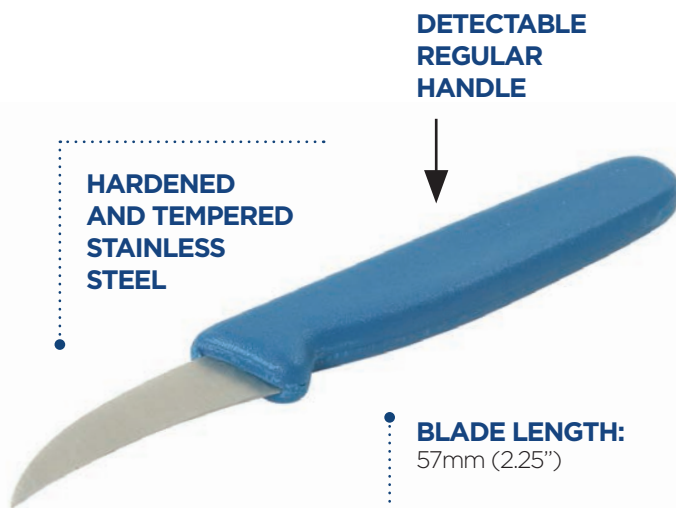

HARDENED AND TEMPERED STAINLESS STEEL

DETECTABLE REGULAR HANDLE

CURVED BLADE

BLADE LENGTH:
57mm (2.25")

SUITABLE FOR PAD PRINTING/LASER ENGRAVING

HANDLE MANUFACTURED FROM EU & FDA FOOD CONTACT APPROVED DETECTABLE POLYMER

PRODUCT CODE: 600-T085

Metal Detectable & X-Ray Visible Paring Knives

FR: Couteaux d'office
 ES: Cuchillos para verduras
 DE: Schälmesser

These detectable paring knives come in two blade and handle lengths and are available in nine different colours.

Features & Options **10 PACK**



Colours:

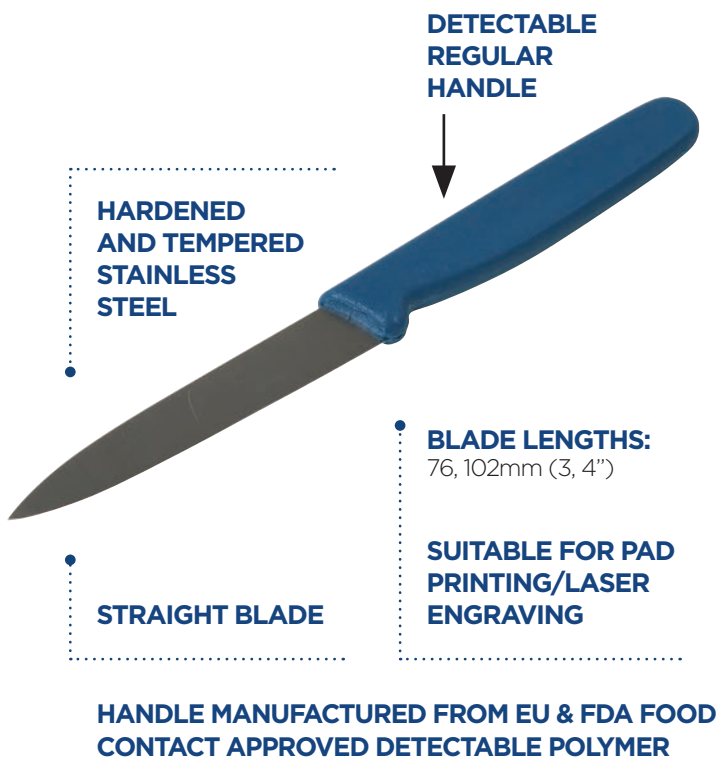

In Partnership with
BREGS

PRODUCT CODE: 600-T056

Sequential numbering available for all products

21

Metal Detectable & X-Ray Visible Broad Flex Filleting Knives

FR: Couteaux à fileter larges flexibles
 ES: Cuchillos de fileteado flexibles y anchos
 DE: Filetmesser mit breiter Klinge

These detectable broad flex filleting knives come in two blade lengths and are available in nine different colours.

Features & Options **10 PACK**



Colours:

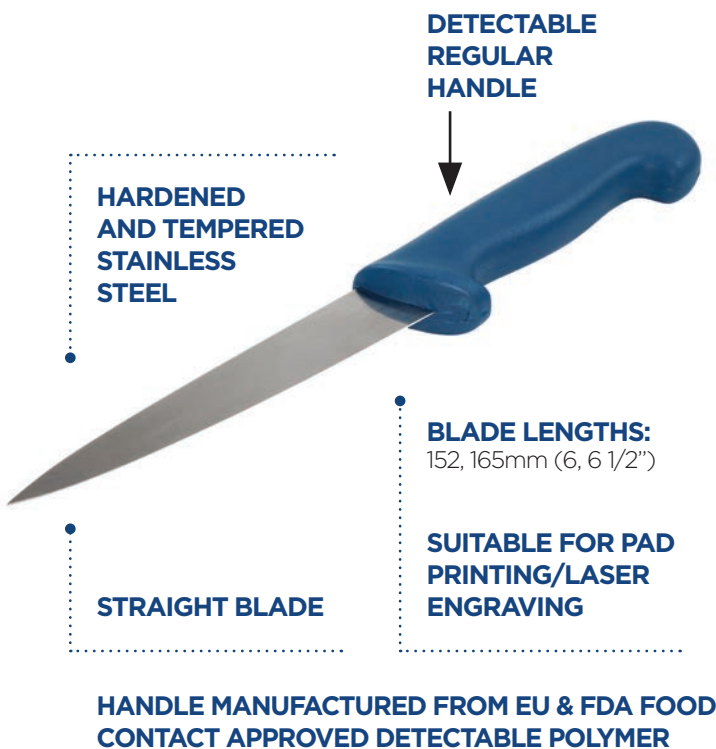

Detectamet

PRODUCT CODE: 600-T053

Metal Detectable & X-Ray Visible Butcher's Knives

FR: Couteau de boucher
 ES: Cuchillo de carnicero
 DE: Metzgermesser

These detectable butcher's knives come in two different blade lengths, both available in nine different colours.

Features & Options

10
PACK



Colours:



HANDLE MANUFACTURED FROM EU & FDA FOOD CONTACT APPROVED DETECTABLE POLYMER

PRODUCT CODE: 600-T048

More product codes available – please contact us for a full price list

Metal Detectable & X-Ray Visible Dough Knives

FR: Couteaux à pâte
 ES: Cuchillos para masa
 DE: Teigmesser

These detectable dough knives have a 203mm (8") curved blade and are available in nine different colours.

Features & Options

10
PACK



Colours:



HANDLE MANUFACTURED FROM EU & FDA FOOD CONTACT APPROVED DETECTABLE POLYMER

PRODUCT CODE: 600-T084

Metal Detectable & X-Ray Visible Wavy Edge Slicers

FR: Couteau à pain

ES: Cuchillo con borde ondulado

DE: Brotmesser

10
PACK

These detectable wavy edge slicers come in two blade lengths, both available in nine different colours.



Features & Options

- Metal detectable
- X-Ray visible
- Handle manufactured from EU & FDA food contact approved detectable polymer
- Hardened and tempered stainless steel
- Serrated blade
- Regular handle
- Blade lengths: 254, 305mm (10, 12")
- Suitable for pad printing/laser engraving



PRODUCT CODE: 600-T046

Metal Detectable & X-Ray Visible Palette Knives

FR: Couteau à palette

ES: Cuchillo de paleta

DE: Palettenmesser

10
PACK

These detectable palette knives come in four blade lengths, all available in nine different colours.



Features & Options

- Metal detectable
- X-Ray visible
- Handle manufactured from EU & FDA food contact approved detectable polymer
- Hardened and tempered stainless steel
- Straight blade
- Regular handle
- Blade lengths: 152, 203, 254, 305mm (6, 8, 10, 12")
- Suitable for pad printing/laser engraving



PRODUCT CODE: 600-T051

Sequential numbering available for all products

Metal Detectable & X-Ray Visible Bread/Pastry Knives

FR: Couteau à pain

ES: Cuchillo con borde ondulado

DE: Brotmesser

10
PACK

These detectable bread/pastry knives have a 254mm (10") blade, and are available in nine different colours.



Features & Options

- Metal detectable
- X-Ray visible
- Handle manufactured from EU & FDA food contact approved detectable polymer
- Hardened and tempered stainless steel
- Serrated blade
- Regular handle
- Blade size: 254mm (10")
- Suitable for pad printing/laser engraving



PRODUCT CODE: 600-T055

Metal Detectable Cutting/Chopping Board

FR: Planche à découper et à hacher

ES: Tabla de cortar/picar

DE: Schneidebrett

1
PACK

This metal detectable chopping board is available in two sizes and has been approved for contact with food.

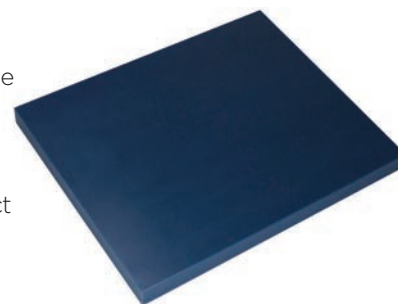

Features & Options

- Metal detectable
- Excellent wear/abrasion resistance
- FDA and EU Directive 2002/72 EC compliant
- Suitable for low temperature environments -260°C (-436°F) up to 80 °C (176 °F)
- Sizes: 610 x 457 x 10mm (24 x 18 x 3/8") 610 x 457 x 50mm (24 x 18 x 2") (other sizes available on request)



PRODUCT CODE: 826-S375-P01 (610 x 457 x 10mm)
826-S376-P01 (610 x 457 x 50mm)

Knife Safety

Having picked the best knife for the job, the next challenge is to ensure the knife is used correctly. If a knife is handled incorrectly, there is a high possibility of either damage to contents, injury or waste contamination.

Tips and techniques:

- Select correct knife
- Train staff to use correctly
- Position package so it's easy to hold and don't overstretch
- Make one clean, firm, effective cut to avoid creation of potential contaminants
- After use retract blade, store knife safely and dispose of rubbish instantly
- Replace blunt blades immediately

Detectamet UK

Unit 1, Halifax Way
Pocklington Industrial Estate
York, YO42 1NR, UK

T: +44 1759 304200

E: sales@detectamet.com
detectamet.co.uk

Detectamet Canada

Unit 13, 2295 Stevenage Drive
Ottawa, Ontario
K1G 3W1, Canada

T: +1-613-736-6560

E: sales@detectamet.ca
detectamet.ca

Find us on:

 Detectamet

 Detectamet

 @Detectamet

Detectamet USA

5111 Glen Alden Drive
Richmond, VA
23231, USA

T: +1-804-303-1983

E: sales@us.detectamet.com
detectamet.com

Detectamet Australia

Unit 2E, 128-130 Frances Street
Lidcombe, Sydney
NSW 2141, Australia

T: +61 2 9058 8555

E: sales@detectamet-products.com.au
detectamet-products.com.au

Detectamet accept no responsibility or liability for any errors or omissions in this catalogue. All information, including the approximate sizes, is provided in good faith and no warranty is given as to its accuracy. Detectamet reserves the right to alter, add or delete products featured in this catalogue and products may vary in design and finish from the ones displayed in this catalogue. All content is protected by copyright and cannot be reproduced without express permission.