



**Detectamet**<sup>TM</sup>  
manufacturer of detectable safety products

# Detectable Clip & Clipboard Guide

View our extensive range of metal detectable and X-ray visible clips and clipboards

**NEW  
PRODUCTS  
INSIDE**

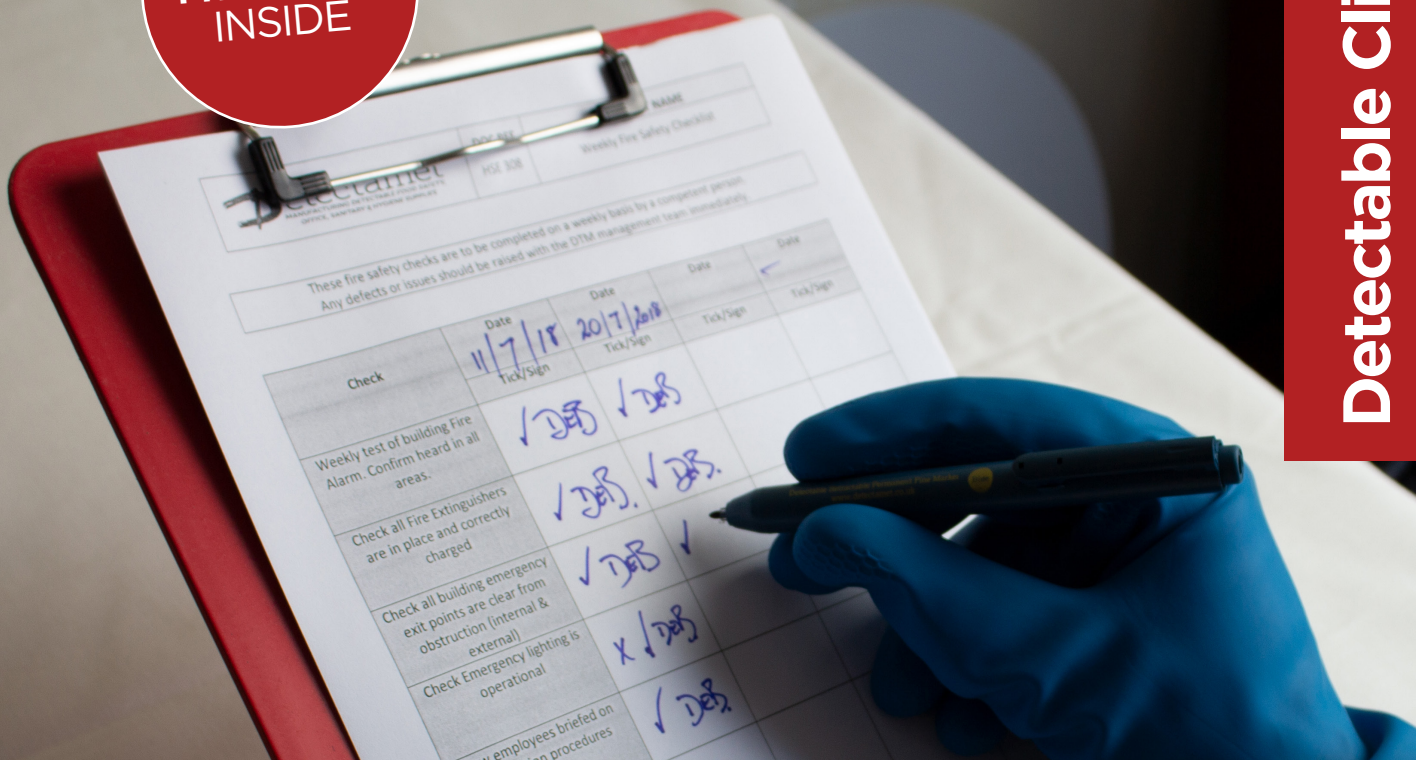

**Detectable Clip & Clipboard Guide 2020**



[detectamet.co.uk](http://detectamet.co.uk)



[detectamet.com](http://detectamet.com)



[detectamet.ca](http://detectamet.ca)



[detectamet-products.com.au](http://detectamet-products.com.au)

# Accreditations



At Detectamet we take our business very seriously, which is why we are ISO accredited in 9001: Quality Management, 14001: Environmental Management and 45001: Occupational Health and Safety

**Awards** - Over the years, we've collected awards for our innovative products



**Chamber  
Bridlington  
& Central Coast  
Business Awards**

## Why you need detectable products:

Food, drink and pharmaceutical industries need to prevent/reduce the risk of foreign body contamination. Physical contaminants can damage equipment and cause injury. If they reach the consumer you will be faced with an expensive recall, which could harm your reputation. The safest way to eliminate and protect against this risk is to use metal detectable and X-ray visible products in all areas of your product preparation areas.

## What do you get from Detectamet:

Detectamet's product range offers you the best detectability, made from a patented, unique polymer that contains the highest level of detectable additive, without compromising on durability, and manufactured from EU & FDA (Food and Drug Administration) food contact approved materials.

- Patented, unique polymer - contains highest levels of detectable additive in the market
- All products comply with EU and FDA food contact regulations
- Durable products - minimise risk of breaking
- Largest range of detectable products on the market
- Branding/serialisation available with in-house laser engraver/pad printer

## Contents

Document Holder	3
Clipboards & Clipboard Options	4-5
Design Your Own Detectamet Clipboard	6-7
Aluminium & Plastic Cardboards	8-9
Clips & Clipboard Clips	10-13
Magnetic & Hanging Clipboards	14-15
Ringbinders, Ringbinder Clipboards & Ringbinder Mechanisms	16-18
Leaver Arch File	19

In Partnership  
with

**BRCS**

2

**Detectamet**

# Metal Detectable & X-Ray Visible Stainless Steel Wall Mountable Document Holder

FR: Support mural pour tablettes en acier inoxydable

ES: Bandeja de acero inoxidable de montaje en pared para tablas sujetapapeles

DE: Klemmbretthalterung aus Edelstahl zur Wandmontage



This wall mountable stainless steel clipboard holder is available in either silver or powder coated in four different colours.

## Features & Options



### HOLDS A3 OR A4 CLIPBOARDS

A3 size 297 x 420mm (11 11/16 x 16 9/16")

A4 size 210 x 297mm (8 1/4 x 11 11/16")



### WALL MOUNTED

### SIZES:

247 x 243 x 40mm (9 3/4 x 9 9/16 x 1 9/16")

holds two or three A4 clipboards

490 x 250 x 40mm (19 5/16 x 9 3/16 x 1 9/16")

holds five or six A4 clip boards or three A3

Colours:

In Partnership with

**BROGS**

3

**Detectamet**

## Metal Detectable & X-Ray Visible Clipboards

Our range of clipboards can be tailored to meet your individual needs. Talk to a sales representative for more details and product codes.

### Features & Options



#### MATERIAL OPTIONS

Aluminium  
Stainless Steel  
Plastic Polymer with metal detectable additive  
Plastic Polymer with metal detectable additive and magnetic strip

#### CLIP TYPE

Heavy Duty Stainless Steel  
Stainless Steel & Chrome  
Economy Clip  
Jumbo Chrome Plated Clip  
Stainless Steel Bulldog  
Serrated Edge  
Zinc Plated with Pen Holder

#### ORIENTATION

Landscape  
Portrait

#### BRANDING

Suitable for laser engraving

#### CLIPBOARD COLOURS

blue, black, red, green, yellow, white, purple, orange, pink, silver

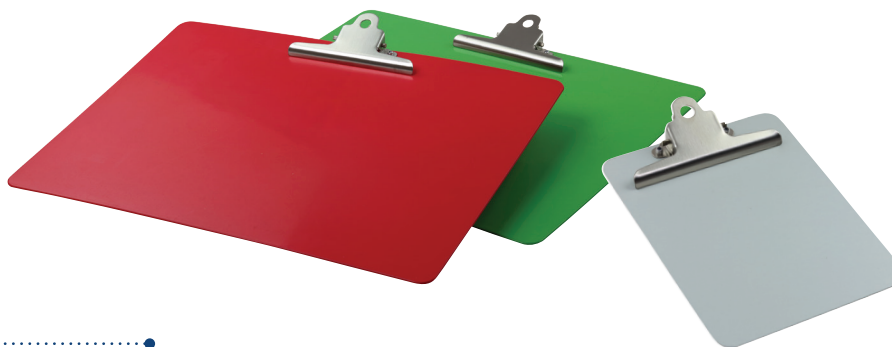

#### THESE CLIPBOARDS ARE DESIGNED TO SUIT STANDARD SIZED PAPER

A3 size 297 x 420mm (11 11/16 x 16 9/16")  
A4 size 210 x 297mm (8 1/4 x 11 11/16")  
A5 size 148 x 210mm (5 13/16 x 8 1/4")

#### ACTUAL CLIPBOARD SIZES

A3 350 x 460mm (13 3/4 x 18 1/8")  
A4 230 x 320mm (9 1/16 x 12 5/8")  
A5 180 x 230mm (7 1/16 x 9 1/16")

#### HANGING OPTION

Rolled hanging hook option suitable for bars up to 45mm (1 3/4") diameter  
Folded hanging hook option suitable for bars up to 30mm (1 3/16") diameter

#### CLIP COLOUR

Silver  
Blue, green, red, yellow (only available in Heavy Duty Stainless Steel and Stainless Steel & Chrome clips)  
Black (only available in Stainless Steel Bulldog clip)

# Clipboard Options

## MATERIAL OPTIONS

Aluminium  
Stainless Steel  
Metal detectable & X-Ray visible plastic



Colours:



## TO FIT PAPER SIZES

A3 size 297 x 420mm (11 11/16 x 16 9/16")  
A4 size 210 x 297mm (8 1/4 x 11 11/16")  
A5 size 148 x 210mm (5 13/16 x 8 1/4")

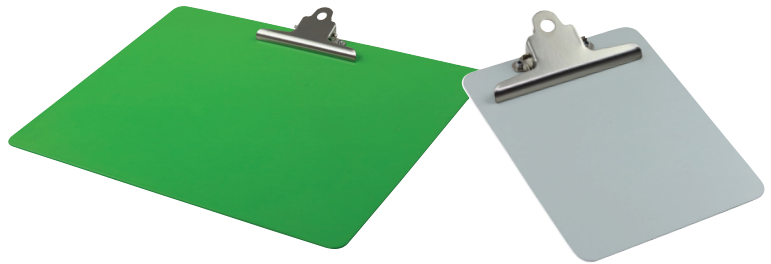

## ORIENTATION

Landscape  
Portrait

## CLIPBOARD CLIP OPTIONS

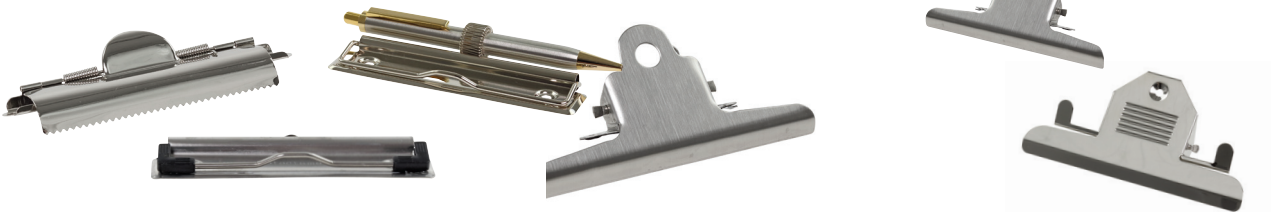

## LASER MARKING

custom printing



## HANGING OPTIONS

Stainless/steel and aluminium available with rolled or folded hanging hooks. Plastic boards available with stainless steel hanging hook

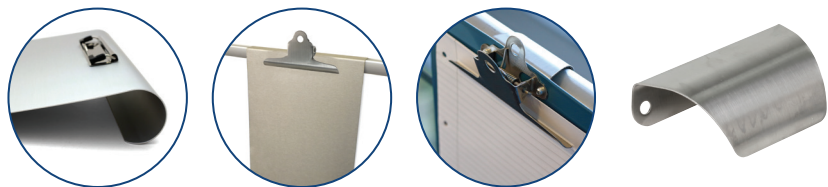

## MULTIPLE CLIPS/BESPOKE BOARDS

Whatever your requirement for a board, we can make it for you



## Design Your Own Detectamet Clipboard

### Step 1 - Board material

- ALUMINIUM     STAINLESS STEEL     DETECTABLE PLASTIC

### Step 2 - Board colour

- BLUE      BLACK      RED      GREEN      YELLOW 
- WHITE      PURPLE      ORANGE      PINK      SILVER 

\*Colours only available in detectable plastic

### Step 3 - Board size

- A3 SIZE**  
350 x 460mm  
(13 3/4 x 18 1/8")
- A4 SIZE**  
230 x 320mm  
(9 1/16 x 12 5/8")
- A5 SIZE**  
180 x 230mm  
(7 1/16 x 9 1/16")

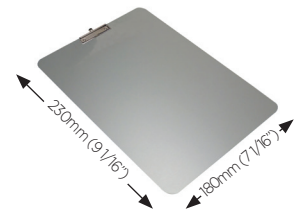
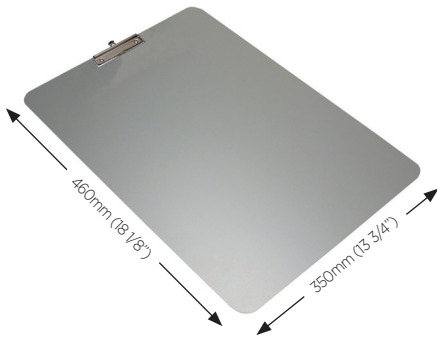

### Step 4 - Portrait or landscape

- PORTRAIT     LANDSCAPE



# Detectable Clip & Clipboard Guide

## Step 5 - Clip or ring binder mechanism type

STAINLESS STEEL ECONOMY CLIP



CHROME ECONOMY CLIP



STAINLESS STEEL HEAVY DUTY CLIP



JUMBO CHROME PLATED CLIP

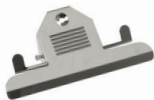

CHROME SERRATED EDGE CLIP



ZINC PLATED CLIP WITH PEN HOLDER



*\*Pen not included*

RING BINDER MECHANISM -  
2 rings inner dia. 30mm (1 3/16")



RING BINDER MECHANISM -  
2 rings inner dia. 43mm (1 11/16")



RING BINDER MECHANISM -  
3 rings inner dia. 30mm (1 3/16")



RING BINDER MECHANISM -  
3 rings inner dia. 43mm (1 11/16")



RING BINDER MECHANISM -  
4 rings inner dia. 43mm (1 11/16")



## Step 6 - No. of clips or ring binder mechanisms

1 CLIP

1 BINDER MECHANISM

2 CLIPS

2 BINDER MECHANISMS

3 CLIPS

3 BINDER MECHANISMS



## Step 7 - Pad print or laser engrave your board

LASER ENGRAVE

PAD PRINT



# Metal Detectable & X-Ray Visible Aluminium or Stainless Steel Clipboard

**FR:** Tablettes en aluminium anodisé ou en acier inoxydable  
**ES:** Tablas sujetapapeles de aluminio anodizado o acero inoxidable  
**DE:** Klemmbretter aus eloxiertem aluminium oder Edelstahl



This clipboard is available in either rolled aluminium or 304 stainless steel to fit A3, A4 and A5 sized paper, flat or folded, in either portrait or landscape. The Aluminium clipboard is anodised to avoid rust and corrosion, making it suitable for use in food processing environments.

In Partnership with  
**BROS**

## Features & Options



SUITABLE FOR LASER ENGRAVING

### A3 SIZE

350 x 460mm  
(13 3/4 x 18 1/8")

### A4 SIZE

230 x 320mm  
(9 1/16 x 12 5/8")

### A5 SIZE

180 x 230mm  
(7 1/16 x 9 1/16")

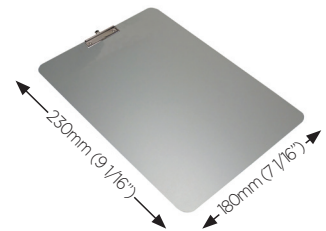
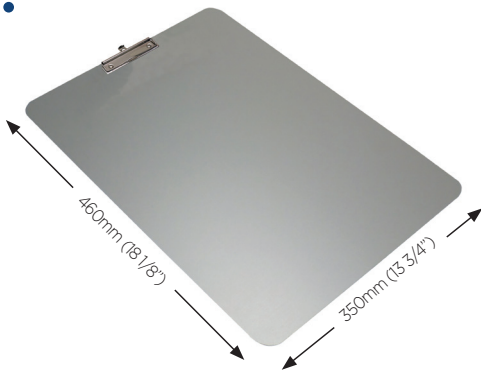

PORTRAIT OR LANDSCAPE



ROLLED OR FOLDED OPTION FOR HANGING

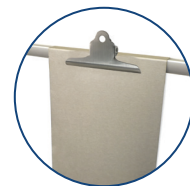

Colour:

PRODUCT CODE: 300-

∞

etectamet



## Metal Detectable & X-Ray Visible Plastic Clipboard

FR: Tablette en plastique entièrement détectable

ES: Tabla sujetapapeles de plástico completamente detectable

DE: Vollständig detektierbares Klemmbrett aus Plastik



This fully detectable plastic clipboard is available in wide range of colours to fit A3, A4 and A5 sized paper, flat or folded, in either portrait or landscape.

### Features & Options

1  
PACK



SUITABLE FOR  
LASER ENGRAVING

#### A3 SIZE

350 x 460mm  
(13 3/4 x 18 1/8")

#### A4 SIZE

230 x 320mm  
(9 1/16 x 12 5/8")

#### A5 SIZE

180 x 230mm  
(7 1/16 x 9 1/16")

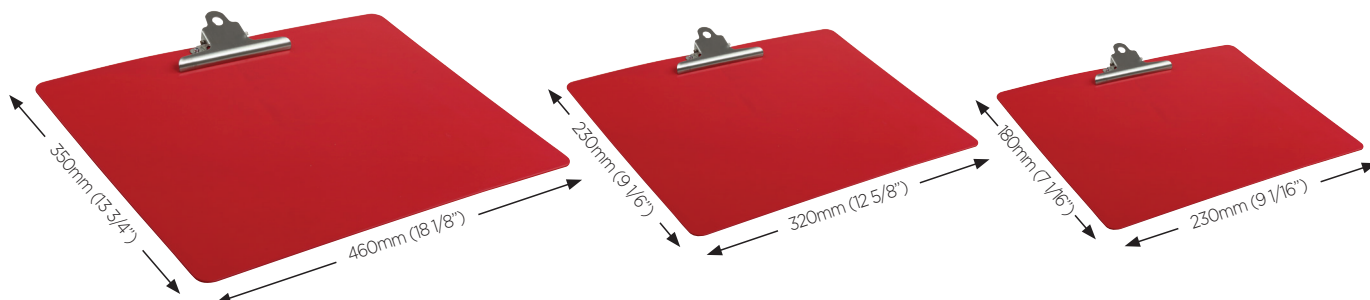

PORTRAIT OR  
LANDSCAPE

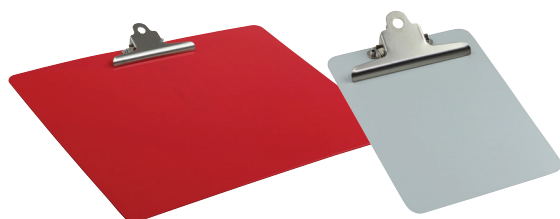

ROLLED OR FOLDED  
OPTION FOR HANGING

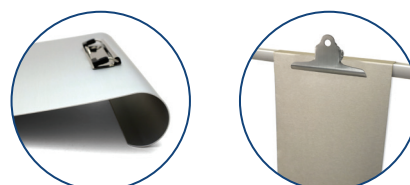

Colours:

PRODUCT CODE: 300-

In Partnership  
with

**BROGS**

9

**Detectamet**

# Detectable Clip & Clipboard Guide

## Metal Detectable & X-Ray Visible Stainless Steel Hanging Hooks

FR: Crochets de suspension pour pinces robustes en acier inoxydable

ES: Ganchos para colgar para sujetapapeles de acero inoxidable de alta resistencia

DE: Aufhängehaken für extrastarke Edelstahlklammern

Attach these stainless steel hanging hooks onto the reverse of clipboards and hang over a door/whiteboard etc. to keep it where it's most needed.



**ONLY SUITABLE FOR USE WITH HD CLIP OR ON ITS OWN**

### Features & Options

**5**  
PACK



Colour:

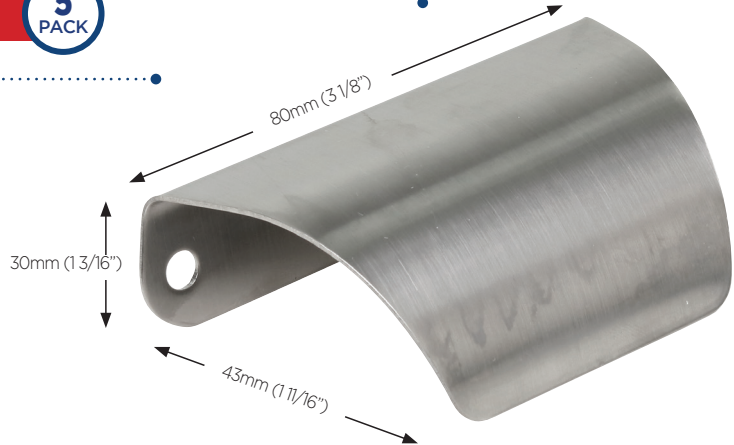

**PRODUCT CODE:** 310-T204

Sequential numbering available for all products • Ask us for a pen and knife guide

## Metal Detectable & X-Ray Visible Stainless Steel & Chrome Economy Clipboard Clips

FR: Pincas économiques en acier inoxydable

ES: Sujetapapeles económicos de acero inoxidable

DE: Edelstahlklammern

Economy stainless steel & chrome clipboard clips are suitable for mounting onto a range of detectable clipboards. Also available with a powder coated finish.

### Features & Options

**5**  
PACK

#### SIZES:

120 x 30mm (4 1/4 x 1 3/16"),  
100 x 30mm (3 15/16 x 1 3/16")  
(chrome, plain finish only)



Colours:

**STAINLESS STEEL OR CHROME**



**HOLDS APPROXIMATELY 50 SHEETS OF PAPER**

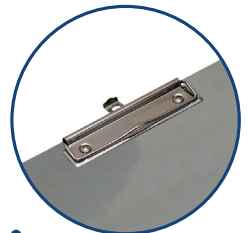

**WITH HANGING HOOK**



100mm (3 15/16")

**SUITABLE FOR LASER ENGRAVING**



30mm (1 3/16")

120mm (4 1/4")

**PRODUCT CODE:** 307-T

# Detectable Clip & Clipboard Guide

## Metal Detectable & X-Ray Visible Heavy Duty Stainless Steel Clipboard Clips

FR: Pincas robustes en acier inoxydable  
ES: Sujetapapeles de acero inoxidable de alta resistencia  
DE: Extrastarke Edelstahlklammern

Heavy duty 100% stainless steel clips for your own use. Suitable for mounting onto a range of detectable clipboards they are available in silver or with a powder coated finish.

HOLDS APPROXIMATELY 100 SHEETS OF PAPER



### Features & Options

5 PACK

SUITABLE FOR LASER ENGRAVING

METAL  
DETECTABLE

X-RAY  
VISIBLE



70mm (2 3/4")

145mm (5 3/4")

Colours:

PRODUCT CODE: 307-T185

Sequential numbering available for all products • Ask us for a pen and knife guide

## Metal Detectable & X-Ray Visible Jumbo Chrome Plated Clips

FR: Pincas chromées jumbo  
ES: Sujetapapeles cromados Jumbo  
DE: Verchromte Riesenklammern

Jumbo chrome plated clipboard clips, suitable for mounting onto a range of detectable clipboards.

HOLDS APPROXIMATELY 150 SHEETS OF PAPER

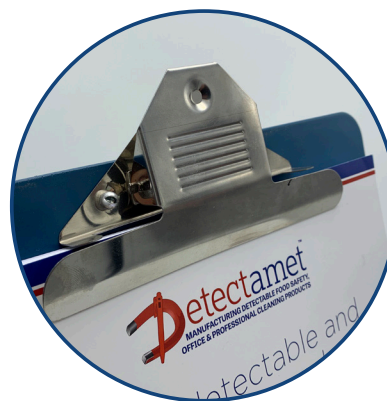

### Features & Options

5 PACK

METAL  
DETECTABLE

X-RAY  
VISIBLE



70mm (2 3/4")

145mm (5 3/4")

Colour:

PRODUCT CODE: 307-T232

In Partnership with  
**BROGS**

11

Detectamet

## Metal Detectable & X-Ray Visible Stainless Steel Jaw Clips

FR: Clips de mâchoire  
 ES: Pinzas de mandíbula  
 DE: Backenclips

Manufactured from stainless steel, including springs, these jaw clips are available in two sizes, both featuring serrated edges on the inside of the 'jaw' clasp for added security.



### Features & Options

5  
PACK

**METAL**  
DETECTABLE

**X-RAY**  
VISIBLE



SUITABLE FOR  
LASER ENGRAVING



Colour:

PRODUCT CODE: 309-S

Sequential numbering available for all products • Ask us for a pen and knife guide

12

## Metal Detectable & X-Ray Visible Stainless Steel Bag Clips

FR: Clips de sac  
 ES: Clips de bolsa  
 DE: Taschenclips

### Features & Options

5  
PACK

Manufactured from stainless steel, including springs, these bag clips are available in a range of sizes.

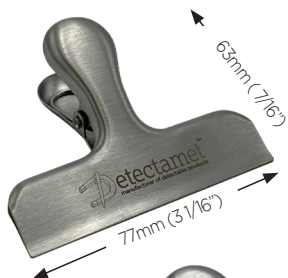

HOLDS  
APPROXIMATELY  
100 SHEETS OF  
PAPER



HOLDS  
APPROXIMATELY  
180 SHEETS OF  
PAPER

Colour:

SUITABLE FOR  
LASER  
ENGRAVING

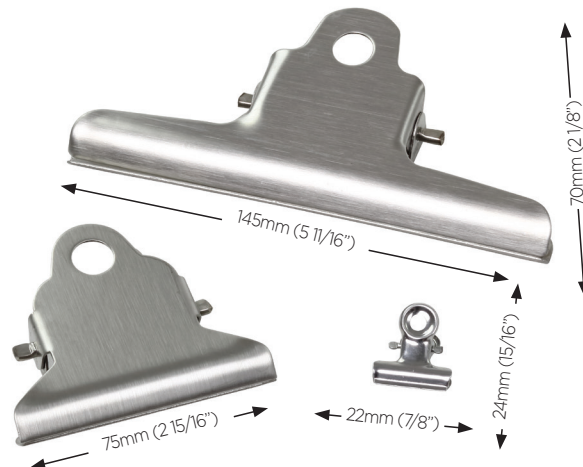

SUITABLE FOR  
POWDER COATING

PRODUCT CODE: 309-S

Detectamet

In Partnership  
with  
BRGS

# Detectable Clip & Clipboard Guide

## Metal Detectable & X-Ray Visible Chrome Serrated Edge Clips

FR: Pincas économiques crantées galvanisées

ES: Sujetapapeles dentados económicos cincados

DE: Verzinkte Klammern mit Kammprofil

Serrated chrome plated clipboard clips, suitable for mounting onto a range of detectable clipboards.

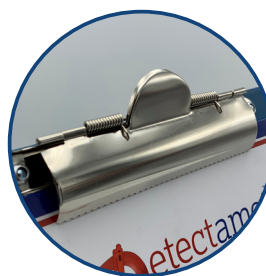

HOLDS  
APPROXIMATELY  
50 SHEETS OF  
PAPER

### Features & Options

5  
PACK

SUITABLE FOR  
LASER ENGRAVING

**METAL**  
DETECTABLE

**X-RAY**  
VISIBLE

Colour:

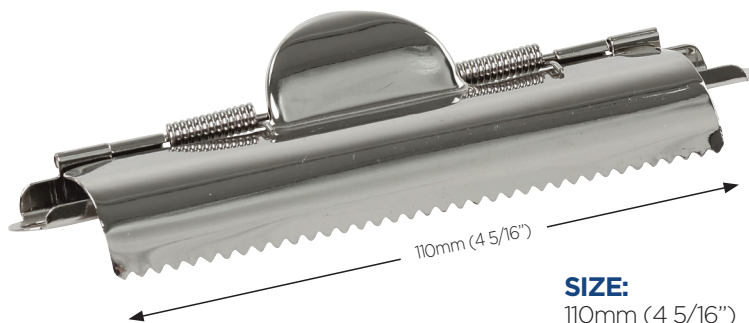

SIZE:  
110mm (4 5/16")

PRODUCT CODE: 313-S631-P42

More product codes available – please contact us for a full price list

## Metal Detectable & X-Ray Visible Zinc Plated Clips with Pen Holders

FR: Pince galvanisée économique avec support pour stylo

ES: Sujetapapeles cincado económico con portabolígrafo

DE: Verzinkte Klemmen mit Stiftehalter

Zinc plated clipboard clips with pen holders, suitable for mounting onto a range of detectable clipboards.

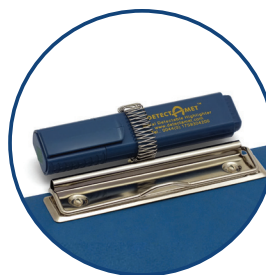

HOLDS  
APPROXIMATELY  
50 SHEETS OF  
PAPER

### Features & Options

5  
PACK

INCLUDES  
PEN HOLDER

**METAL**  
DETECTABLE

**X-RAY**  
VISIBLE

Colour:



\*Pen not  
included

SUITABLE FOR  
LASER ENGRAVING

SIZE:  
120 x 30mm  
(4 3/4 x 1 1/4")

PRODUCT CODE: 307-T188

In Partnership  
with  
**BROGS**

13

**Detectamet**

# Metal Detectable & X-Ray Visible Magnetic Clipboard

**FR:** Tablettes magnétiques détectables  
**ES:** Tablas sujetapapeles magnéticas detectables  
**DE:** Detektierbare magnetische Klemmbretter



This magnetic clipboard is available in a wide range of colours and sizes, with a very strong magnet that sticks to most ferrous surfaces such as whiteboards, machines, metal partitions etc.

## Features & Options



In Partnership with  
**BROGS**



**SUITABLE FOR  
LASER ENGRAVING**

**A3 SIZE**  
350 x 460mm  
(13 3/4 x 18 1/8")

**A4 SIZE**  
230 x 320mm  
(9 1/16 x 12 5/8")

**A5 SIZE**  
180 x 230mm  
(7 1/16 x 9 1/16")

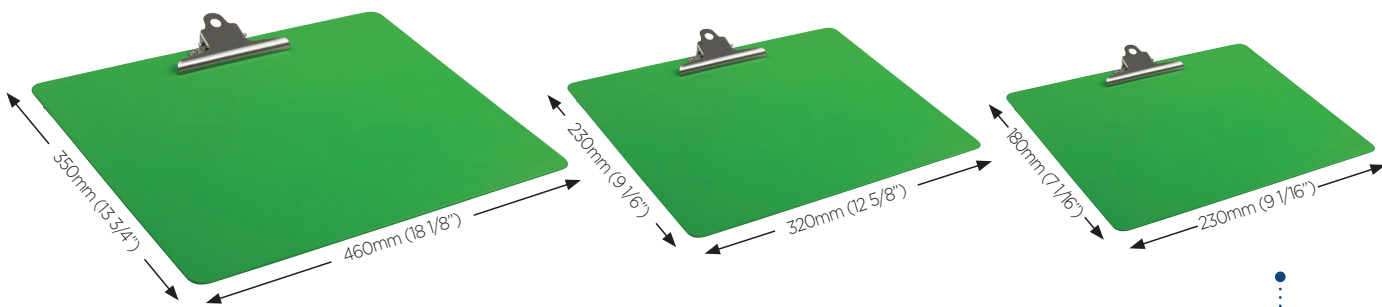

**AVAILABLE IN ALUMINIUM, STAINLESS  
STEEL AND PLASTIC**

**PORTRAIT OR  
LANDSCAPE**

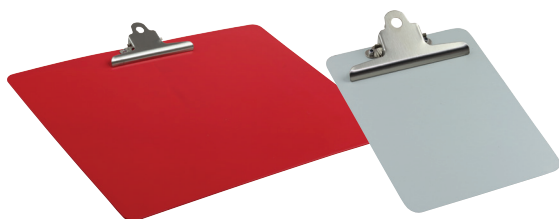

Colours:

## Metal Detectable & X-Ray Visible Stainless Steel or Aluminium Hanging Clipboard

FR: Tablettes suspendues en acier inoxydable et en aluminium

ES: Tablas sujetapapeles para colgar de acero inoxidable o aluminio

DE: Aufhängbare Klemmbretter aus Edelstahl und Aluminium

This stainless steel or aluminium hanging clipboard comes either folded or rolled for hanging.



1  
PACK

### Features & Options



PLEASE ASK  
US ABOUT  
BESPOKE SIZES

SUITABLE  
FOR LASER  
ENGRAVING

#### A3 SIZE

350 x 460mm  
(13 3/4 x 18 1/8")



#### A4 SIZE

230 x 320mm  
(9 1/16 x 12 5/8")

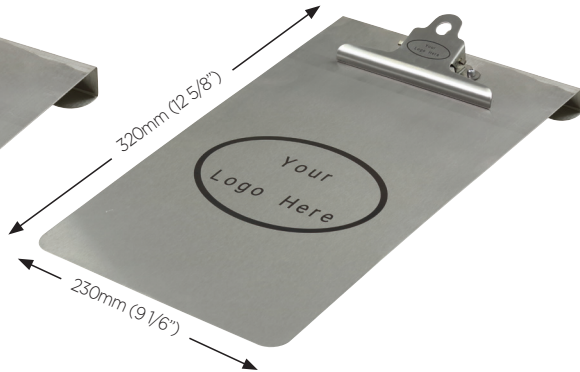

#### ROLLED OPTION

suitable for hanging over bars up to 50mm (2")



#### ROLLED

55 x 40mm  
(2 3/16 x 1 9/16")



#### FOLDED

20 x 20mm  
(13/16 x 13/16")

#### FOLDED OPTION

suitable for hanging over bars up to 18mm (11/16")

ANODISED ALUMINIUM  
& STAINLESS STEEL

Colour:

PORTRAIT OR  
LANDSCAPE

PRODUCT CODE: 300-O

In Partnership  
with

BROGS

15

Detectamet

## Metal Detectable & X-Ray Visible Ring Binder Clipboard

**MADE IN BRITAIN**

FR: Porte-bloc à anneaux

ES: Tabla sujetapapeles con archivador

DE: Ringordner-Klemmbrett

Keep documents together in processing areas with this detectable ring binder clipboard, available in a number of colours.



**AVAILABLE WITH 2, 3 OR 4 RINGS**

### A5 SIZE

180 x 230mm  
(7 1/16 x 9 1/16")

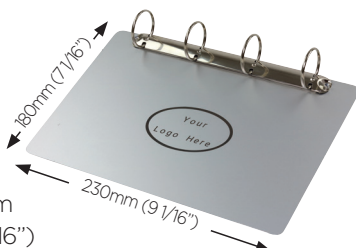

### A4 SIZE

230 x 320mm  
(9 1/16 x 12 5/8")

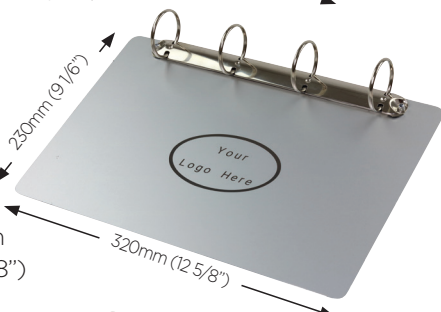

### A3 SIZE

350 x 460mm  
(13 3/4 x 18 1/8")

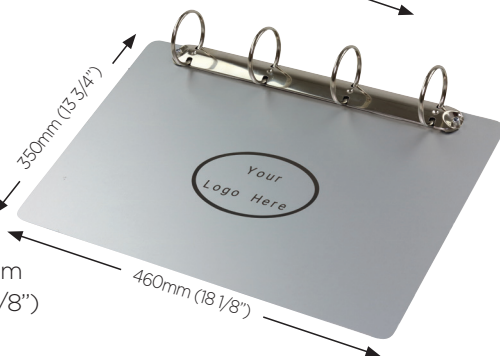

### Features & Options

**1**  
PACK



**AVAILABLE IN PLASTIC, ANODISED ALUMINIUM & STAINLESS STEEL**



**SUITABLE FOR LASER ENGRAVING**

Colours:

**PRODUCT CODE:** 300-

Sequential numbering available for all products • Ask us for a pen and knife guide

16

## Metal Detectable & X-Ray Visible Magnetic Multi-Purpose Holders

FR: Support magnétique multifonctionnel

ES: Soporte magnético multiusos

DE: Detektierbare magnetische Klemmbretter

Strong magnetic multi-purpose holders for hanging paperwork on any ferrous surface e.g. whiteboards, machines, metal partitions etc.

**SUITABLE FOR LASER ENGRAVING**

### INNER RING DIAMETER

43mm (1 11/16")  
or 30mm (1 3/16")

### RING SPACING

104mm (4 1/8")

### Features & Options

**10**  
PACK



### SIZES:

324 x 75 x 67mm  
(12 3/4 x 2 15/16 x 2 5/8")

**AVAILABLE WITH 2, 3 OR 4 RINGS**

Colours: Rings:

**PRODUCT CODE:** 316-P42

Detectamet

In Partnership with  
**BRGS**



# Metal Detectable & X-Ray Visible Chrome Ring Binder Mechanisms

FR: Mécanisme de reliure à anneaux chromés

ES: Mecanismo de archivado cromado

DE: Ringordner-Mechanismus aus Chrom

Keep your important documents bound together with these chrome plated ring binder mechanisms with 2, 3 or 4 rings.

## Features & Options

10  
PACK

**METAL**  
DETECTABLE

**X-RAY**  
VISIBLE

2, 3 OR 4 RINGS

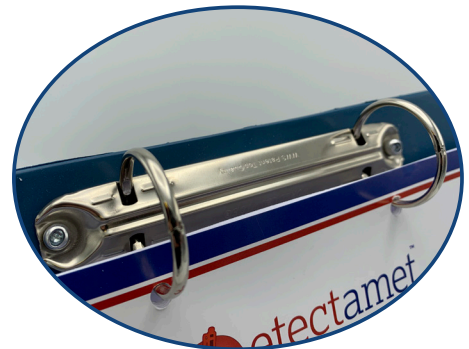

SUITABLE  
FOR LASER  
ENGRAVING

RING BINDERS HOLD  
250+ SHEETS OF  
PAPER



Colour:

PRODUCT CODE: 316-P42-A

In Partnership  
with  
**BROGS**

17

**Detectamet**

# Metal Detectable & X-Ray Visible Stainless Steel or Aluminium Ring Binder

FR: Classeurs à anneaux en acier inoxydable et aluminium

ES: Archivadores con anillos de acero inoxidable y aluminio

DE: Ringordner aus Edelstahl und Aluminium

This 304 stainless steel or anodised aluminium ring binder is available with 2, 3 or 4 rings, and can be powder coated for your colour coding requirements.

## Features & Options

1  
PACK



SUITABLE FOR  
LASER ENGRAVING

### A3 SIZE

297 x 420mm  
(11 11/16 x 16 9/16")

### A4 SIZE

210 x 297mm  
(8 1/4 x 11 11/16")

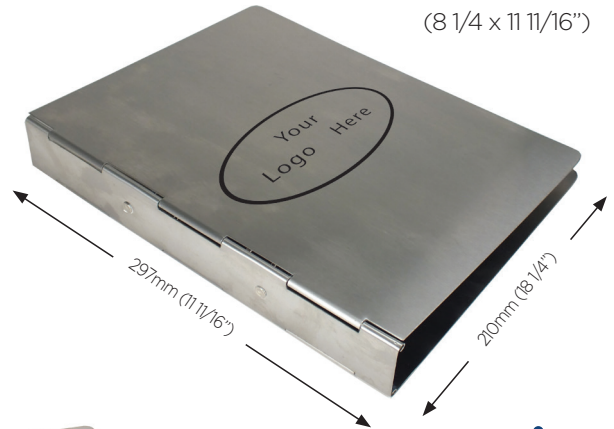
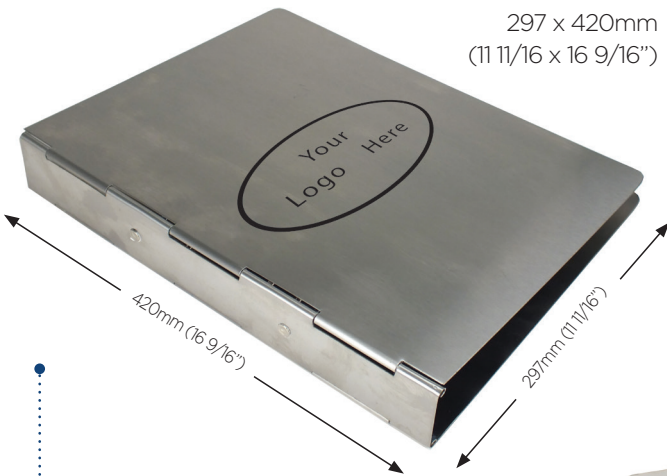

AVAILABLE WITH  
2, 3 OR 4 RINGS



HOLDS UP TO  
350 SHEETS OF  
80GSM PAPER

PORTRAIT AND  
LANDSCAPE

Colours:

PRODUCT CODE: 311-P

# Metal Detectable & X-Ray Visible Stainless Steel or Aluminium Lever Arch File

FR: Classeurs en acier inoxydable et en aluminium

ES: Archivadores con anillos de acero inoxidable y aluminio

DE: Ringordner aus Edelstahl und Aluminium

A4 lever arch file, available in 304 stainless steel or anodised aluminium.

## Features & Options

1  
PACK

 METAL  
DETECTABLE

 X-RAY  
VISIBLE

SUITABLE FOR  
LASER ENGRAVING

HOLDS UP TO  
700 SHEETS OF  
80GSM PAPER

**A4 SIZE**  
255 x 310 x 50mm  
(10 x 12 1/4 x 2")

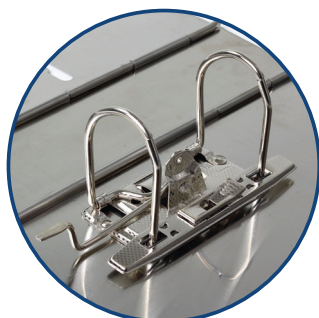

310mm (12 1/4")

50mm (2")

255mm (10")

**RING  
SPACING**  
76mm (3")

**RING DIAMETER  
AT HIGHEST POINT**  
67mm 2 5/8")

Colour: 

In Partnership  
with  
**BROGS**

19

**Detectamet**

**PRODUCT CODE: 317-P32-O18**

## **Detectamet UK**

Unit 1, Halifax Way  
Pocklington Industrial Estate  
York, YO42 1NR, UK

**T:** +44 1759 304200

**E:** sales@detectamet.com  
detectamet.co.uk

## **Detectamet Canada**

Unit 13, 2295 Stevenage Drive  
Ottawa, Ontario  
K1G 3W1, Canada

**T:** +1-613-736-6560

**E:** sales@detectamet.ca  
detectamet.ca

## **Find us on:**

 Detectamet

 Detectamet

 @Detectamet

## **Detectamet USA**

5111 Glen Alden Drive  
Richmond, VA  
23231, USA

**T:** +1-804-303-1983

**E:** sales@us.detectamet.com  
detectamet.com

## **Detectamet Australia**

Unit 2E, 128-130 Frances Street  
Lidcombe, Sydney  
NSW 2141, Australia

**T:** +61 2 9058 8555

**E:** sales@detectamet-products.com.au  
detectamet-products.com.au

Detectamet accept no responsibility or liability for any errors or omissions in this catalogue. All information, including the approximate sizes, is provided in good faith and no warranty is given as to its accuracy. Detectamet reserves the right to alter, add or delete products featured in this catalogue and products may vary in design and finish from the ones displayed in this catalogue. All content is protected by copyright and cannot be reproduced without express permission.

